



LED SVETILJKE ZA PRODAVNICE



FINA TEHNO LED



design by BNM

SHUTTLE







Seriya svetilji SHUTTLE 1-40W plod je višegodišnjeg rada stručnjaka firme Fina Tehno Led iz Srbije. U izradi dizajna ove serije svetiljki pomogla nam je dugogodišnja saradnja sa poznatim arhitektama iz Srbije i inostranstva na prestižnim objektima.

Ova serija nadgradnih svetiljki ima višestruku primenenu u velikom broju prostora, koji se razlikuju kako po nameni tako i po funkciji.

Svetiljke se mogu montirati na strujne šine, na plafon ili zid.

Svetiljke su grupisane po snazi ugrađene diode:

Shuttle 95 40W

Shuttle 75 35W

Shuttle 75 26W

Shuttle 69 18W

Shuttle 50 13W

Shuttle 45 7-10W

Shuttle 35 5W

Shuttle 20 1-3W

Oblik svetiljki je jednostavan i nenametljiv. Ideja dizajnera bila je da se posebno obrati pažnja na kvalitet svetla i komponenti koje su ugrađene u ovu seriju svetiljki. U tu svrhu, korišćene su diode poznatih brendova za proizvodnju LED dioda, SHARP (Japan) i CREE (USA). Drajveri koji se ugrađeni u ovu seriju svetiljki su od poznatog proizvođača TRIDONIK.

Posebna pažnja je posvećena optici tako da imamo super spot, spot i flood optiku.



SHUTTLE 95 40W

1. Kućište od visokokvalitetnog aluminijuma zaštićeno epoksidnom bojom u prahu na temperaturi od 180°C.
2. Reflektor sa visokom refleksijom pomocu vakumski nanesenog aluminijuma.
3. Horizontalno okretanje 355°, vertikalno okretanje 180°.

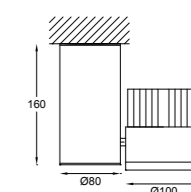
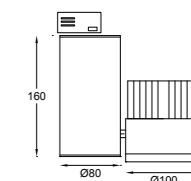

IP40

LED:	Snaga:	Temperatura boje:	Svetlosni flux:	CRI:	Ugao isijavanja:	Boja:
Sharp COB	40 W	3000 K	3800 lm	82	15D - 15°	A01 - bela
		4000 K	4060 lm	82	25D - 25°	A02 - crna
					60D - 60°	A03 - siva
						A04 - metalik aluminijum

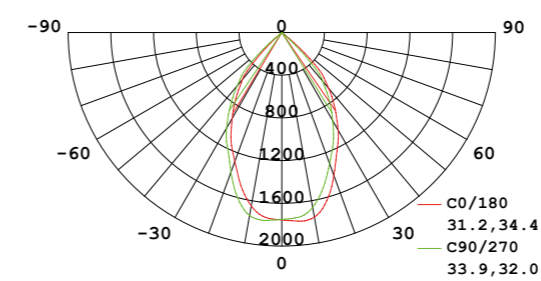
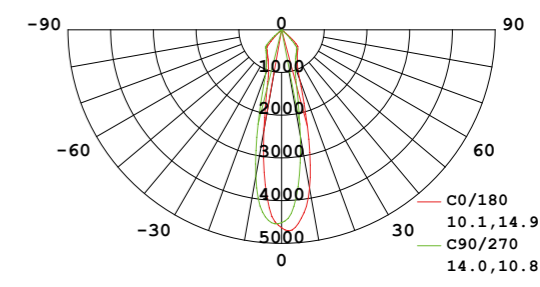
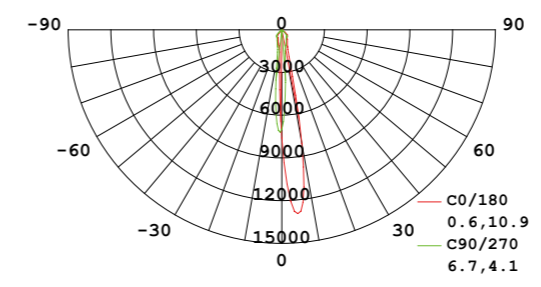



Hotel "Jump Inn", Beograd



SHUTTLE-VD 95 40W

1. Kućište od visokokvalitetnog aluminijuma zaštićeno epoksidnom bojom u prahu na temperaturi od 180°C.
2. Reflektor sa visokom refleksijom pomocu vakumski nanesenog aluminijuma.
3. Horizontalno okretanje 355°, vertikalno okretanje 180°.
4. Reflektor bez dražvera, za trougaonu konstrukciju.

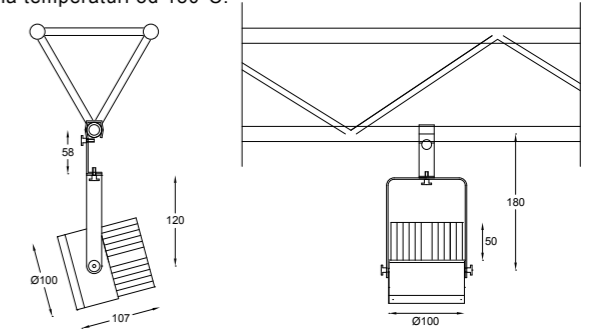

IP40

LED:	Snaga:	Temperatura boje:	Svetlosni flux:	CRI:	Ugao isijavanja:	Boja:
Sharp COB	40 W	3000 K	3800 lm	82	15D - 15°	A01 - bela
		4000 K	4060 lm	82	25D - 25°	A02 - crna
					60D - 60°	A03 - siva
						A04 - metalik aluminijum

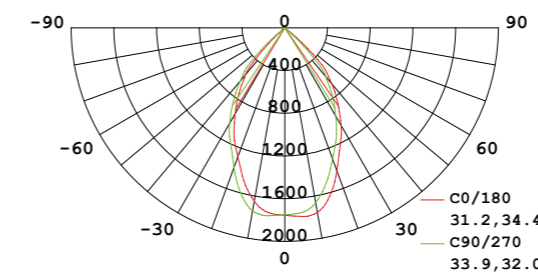
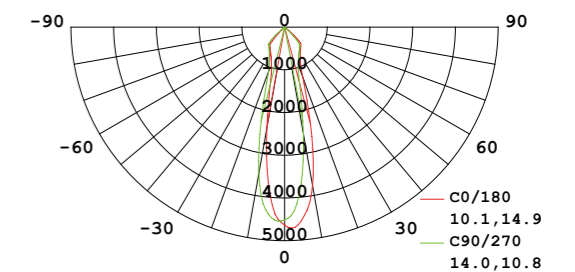
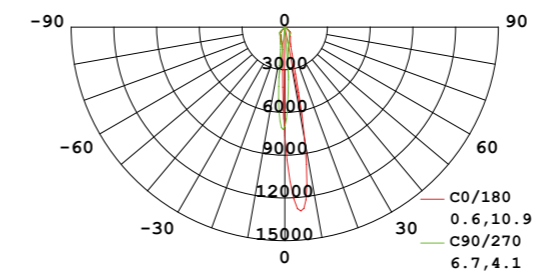

"Prodavnica 'List', Beograd



SHUTTLE-K 95 40W

1. Kućište od visokokvalitetnog aluminijuma zaštićeno epoksidnom bojom u prahu na temperaturi od 180°C.
2. Reflektor sa visokom refleksijom pomocu vakumski nanesenog aluminijuma.
3. Horizontalno okretanje 355°, vertikalno okretanje 180°.

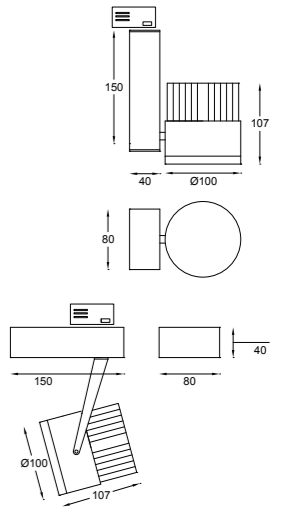

IP40

LED:	Snaga:	Temperatura boje:	Svetlosni flux:	CRI:	Ugao isijavanja:	Boja:
Sharp COB	40 W	3000 K	3800 lm	82	15D - 15°	A01 - bela
		4000 K	4060 lm	82	25D - 25°	A02 - crna
					60D - 60°	A03 - siva
						A04 - metalik aluminijum

Prodavnica "Mona", Leskovac

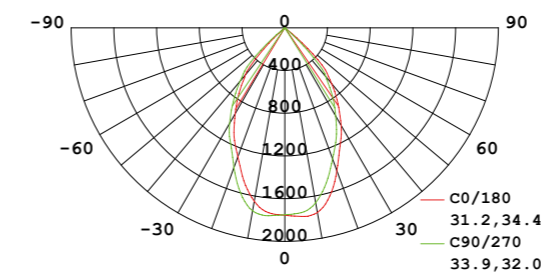
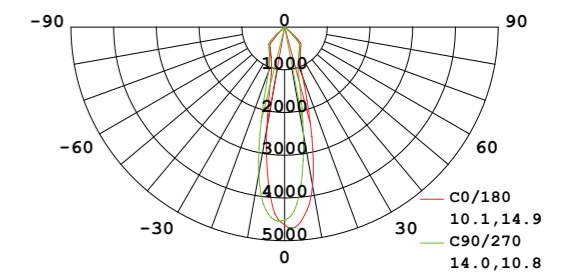
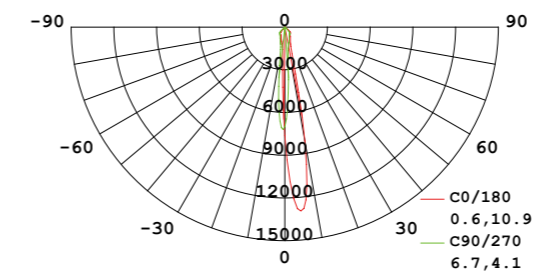





SHUTTLE 75 35W

1. Kućište od visokokvalitetnog aluminijuma zaštićeno epoksidnom bojom u prahu na temperaturi od 180°C.
2. Reflektor sa visokom refleksijom pomoću vakumski nanesenog aluminijuma.
3. Horizontalno okretanje 355°, vertikalno okretanje 180°.
4. Dve verzije: SHUTTLE za šinsku montažu i SHUTTLE/F za fiksnu montažu.

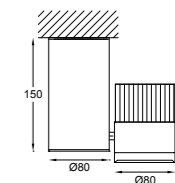
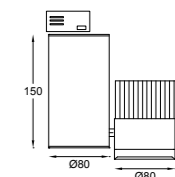

IP40

LED:	Snaga:	Temperatura boje:	Svetlosni flux:	CRI:	Ugao isijavanja:	Boja:
Sharp COB	35 W	3000 K	3800 lm	80	15D - 15°	A01 - bela
		4000 K	4060 lm	80	25D - 25°	A02 - crna
		3000 K	3250 lm	90	60D - 60°	A03 - siva
		4000 K	3350 lm	90		A04 - metalik aluminijum

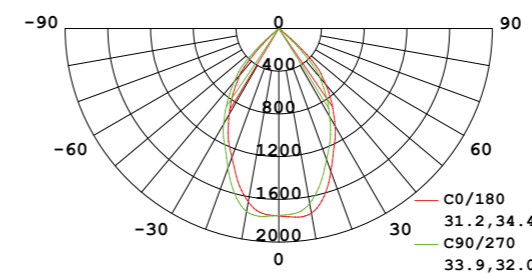
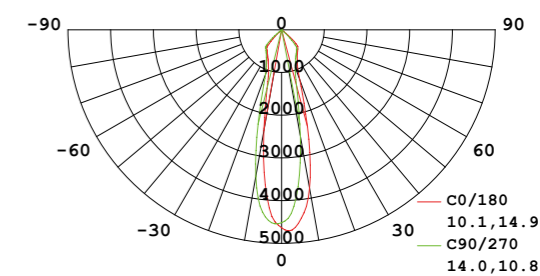
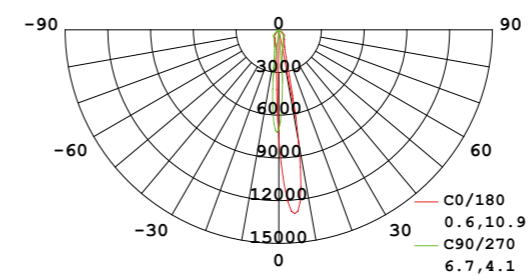





SHUTTLE 75 26W

1. Kućište od visokokvalitetnog aluminijuma zaštićeno epoksidnom bojom u prahu na temperaturi od 180°C.
2. Reflektor sa visokom refleksijom pomoću vakumski nanesenog aluminijuma.
3. Horizontalno okretanje 355°, vertikalno okretanje 180°.
4. Dve verzije: SHUTTLE za šinsku montažu i SHUTTLE/F za fiksnu montažu.

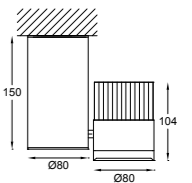
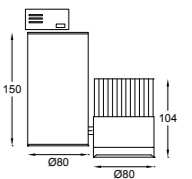

IP40

LED:	Snaga:	Temperatura boje:	Svetlosni flux:	CRI:	Ugao isijavanja:	Boja:
Sharp	26 W	3000 K	2950 lm	80	15D - 15°	A01 - bela
		4000 K	3100 lm	80	25D - 25°	A02 - crna
		3000 K	2415 lm	90	40D - 40°	A03 - siva
		4000 K	2525 lm	90	60D - 60°	A04 - metalik aluminijum

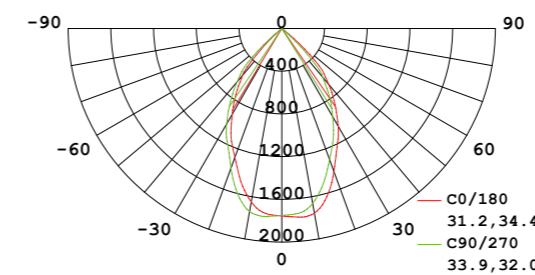
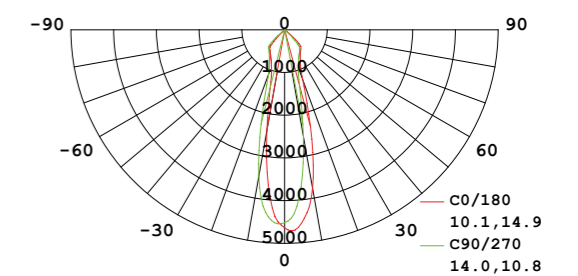
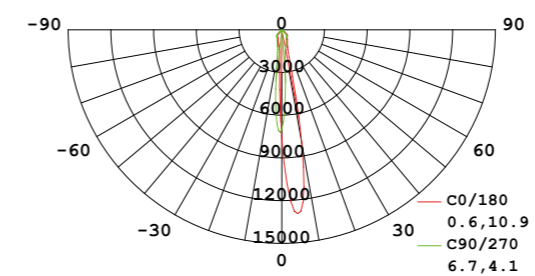





SHUTTLE 69 18W

1. Kućište od visokokvalitetnog aluminijuma zaštićeno epoksidnom bojom u prahu na temperaturi od 180°C.
2. Reflektor sa visokom refleksijom pomoću vakumski nanesenog aluminijuma.
3. Horizontalno okretanje 355°, vertikalno okretanje 180°.
4. Dve verzije: SHUTTLE za šinsku montažu i SHUTTLE/F za fiksnu montažu.

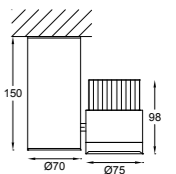
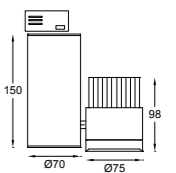

IP40

LED:	Snaga:	Temperatura boje:	Svetlosni flux:	CRI:	Ugao isijavanja:	Boja:
Sharp	18 W	3000 K 4000 K	1395 lm 1495 lm	80 80	15D - 15° 24D - 24° 36D - 36°	A01 - bela A02 - crna A03 - siva A04 - metalik aluminijum

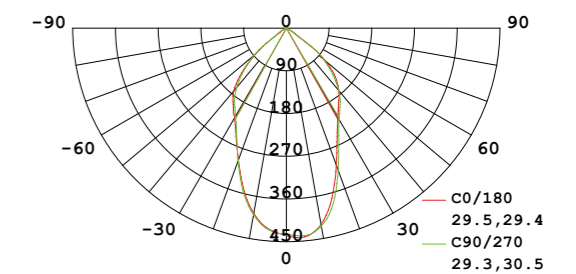





LED PIK



Svetiljke iz serije Led PIK 1-40W napravljene su u više veličina i koriste LED diode CREE 1-3W i Sharp COB 5, 7, 10, 13, 18, 26, 35 i 40W. Više svetiljki je okruglog oblika, a manji deo može biti i četvrtastog oblika.

Svetiljke iz ove serije su fiksne.

Prilikom izrade dizajna ove svetiljke vodili smo računa da one budu jednostavnog oblika, odnosno da naglasak bude na odsijačima i samoj COB diodi.



Svetiljka LED PIK 95 40W koristi COB diode 3000K i 4000K sa visokim CRI > 90.

Svetiljka LED PIK 95 35W MT/BR/FR koristi diode za specijalne namene tj. za osvetljenje:

Mesa:	LED PIK 95 35W MT
Hleba i peciva:	LED PIK 95 35W BR
Voća i povrća:	LED PIK 95 35W FR

Upotreba svetiljki iz serije Led PIK je velika, a posebno kada je u pitanju odnos cene i kvaliteta svetiljki. Primena: hoteli, privatne rezidencije, holovi, restorani, prodajni prostori, kupatila, prodajni prostor za meso, hleb, ribu, voće i povrće.

Svetiljke Led PIK izradjene su u četiri osnovne boje: bela, crna, siva i metalik aluminijum.

Dizajn ovih svetiljki koristi zaštićeni znak firme Fina Tehno Led i Devotee: design by BNM.



LED PIK 95 26-35-40W

1. Okrugla ugradna svetiljka sa COB LED diodom snage 26W, 35W ili 40W.
2. Svetiljka je fiksna. Odsijač od polikarbonata sa vakuumski nanesenim aluminijumom visoke čistoće.
3. Kućište svetiljke je napravljeno od aluminijuma.
4. Hladnjak "PIN heat sink" izrađen od aluminijuma AL1070.
5. Svetiljka se ugrađuje u spuštenu plafon pomoću dve torzione opruge.
6. Svetiljka je dimenzije Ø130mm h=115mm, ugradni otvor Ø115mm h_{min}=120mm. Težina svetiljke je 700g.
7. Uključenje: Standard ON/OFF, Dim. cut-off triac, Dim. 1-10V, Dim. Remote 1-100%, DALI.

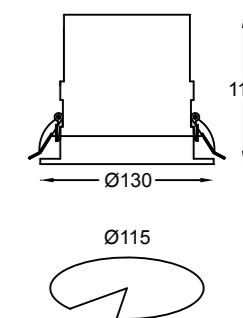

IP40

LED:	Snaga:	Temperatura boje:	Svetlosni flux:	CRI:	Ugao isijavanja:	Boja:
SHARP COB	26W	3000K	2950 lm	80	15D - 15°	bela
	26W	4000K	3100 lm	80	25D - 25°	crna
	26W	3000K	2415 lm	90	60D - 60°	siva
	26W	4000K	2525 lm	90		metalik
	35W	3000K	3800 lm	80		
	35W	4000K	4060 lm	80		
	35W	3000K	3250 lm	90		
	35W	4000K	3350 lm	90		
	40W	3000K	3800 lm	82		
	40W	4000K	4060 lm	82		

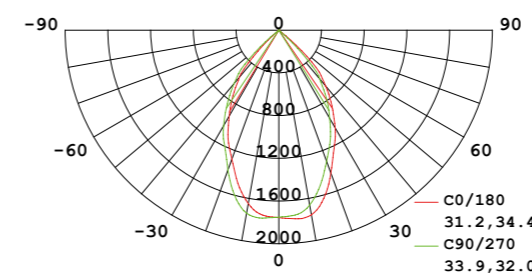
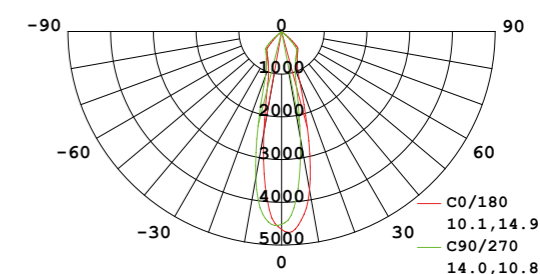
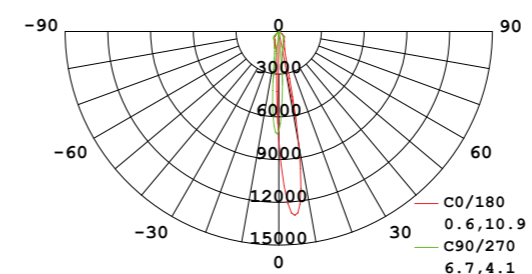

Prodavnica "Mona", Leskovac



Hotel "Radisson Blue", Beograd





LED PIK 69-DEEP 13-18W

1. Okrugla ugradna svetiljka sa COB LED diodom snage 13W ili 18W.
2. Svetiljka je fiksna. Odsijač od polikarbonata sa vakuumski nanesenim aluminijumom visoke čistoće.
3. Kućište svetiljke je napravljeno od aluminijuma.
4. Hladnjak "PIN heat sink" izrađen od aluminijuma AL1070.
5. Svetiljka se ugrađuje u spuštenu plafon pomoću dve torzione opruge.
6. Svetiljka je dimenzije Ø90mm h=87mm, ugradni otvor Ø85mm h_{min}=95mm. Težina svetiljke je 300g.
7. Uključenje: Standard ON/OFF, Dim. cut-off triac, Dim. 1-10V, Dim. Remote 1-100%, DALI.

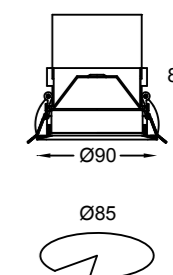

Apartmanski kompleks "Dukley Gardens", Budva

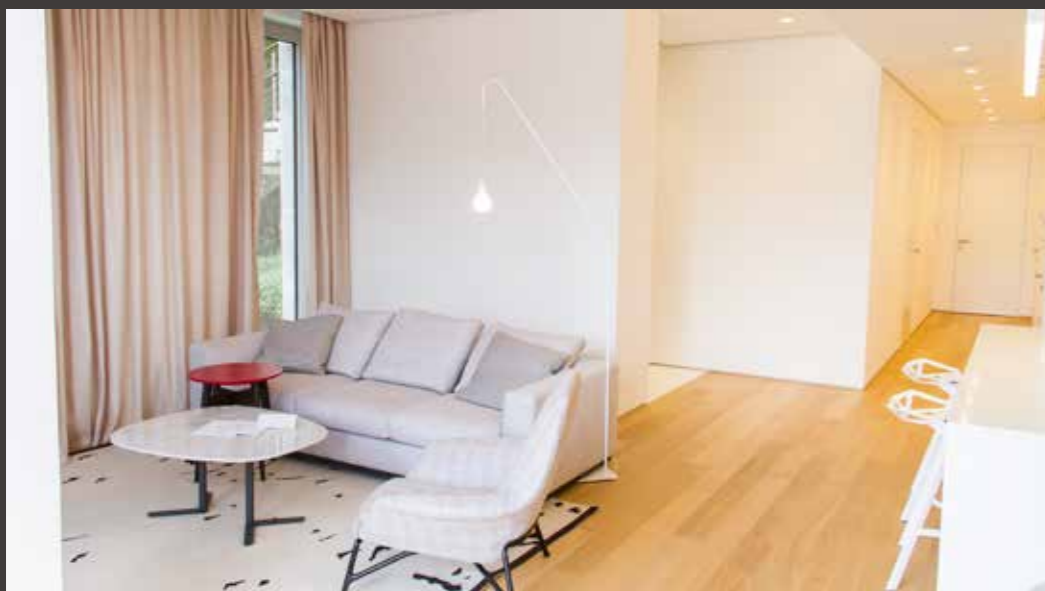

IP40

LED:	Snaga:	Temperatura boje:	Svetlosni flux:	CRI:	Ugao isijavanja:	Boja:
SHARP COB	13W	3000K	1150 lm	80	15D - 15°	bela
	13W	4000K	1230 lm	80	25D - 25°	crna
	13W	3000K	930 lm	90	40D - 40°	siva
	13W	4000K	965 lm	90	60D - 60°	metalik
	18W	3000K	1395 lm	80		
	18W	4000K	1495 lm	80		

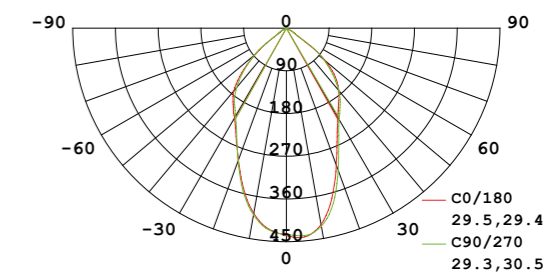



Hotel "Jump Inn", Beograd



LED Q







Svetiljke iz serije LED Q 1-35W napravljene su u više veličina i koriste LED diode CREE 1-3W i LED COB 5, 7, 10, 13, 18, 26 i 35W.

Osnovna geometrija svetiljke je četvrtasti ukrasni ram, po čemu je svetiljka dobila ime LED Q. Svetiljke iz ove serije su ugradne fiksne ili pokretne u dve ose do max.30 stepeni. Prilikom izrade konstrukcije vodilo se računa da svetiljka bude jednostavnih linija i da ima mogućnost podešavanja u dve ose.

Svetiljke serije LED Q, pokretne, izrađene su u različitim veličinama, prema snazi ugrađene diode:

LED Q mini 1-3W

LED Q 40 1x, 2x i 3x 1-3W

LED Q 60 1x, 2x i 3x 5W

LED Q 80 1x, 2x i 3x 7-10-13W

LED Q 100 1x, 2x i 3x 26-35W

Upotreba svetiljki iz serije LED Q je ekstremno velika i daje velike mogućnosti arhitektama i investitorima da kreiraju ambijent po svojoj želji. Posebna odlika je veoma visok index reprodukcije boja CRI (>80, >90 do max 97), kao i RGB verzija.

Svetiljka LED Q 80 1x, 2x i 3x može da koristi RGB+W CREE diodu 4x1-2W.

Svetiljke LED Q izrađene su u četiri osnovne boje: bela, crna, sivi ram + telo crno i metalik aluminijum.

Upotreba: hoteli, privatne rezidencije, holovi, restorani, izložbeni prostori, prodavnice itd.

Dizajn ovih svetiljki koristi zaštićeni znak firmi Fina Tehno LED i Devotee: Design by BNM.



LED Q 100 1x26-35W

1. Ugradna pokretna svetiljka sa jednom COB LED diodom snage 26 ili 35W.
2. Kućište svetiljke izrađeno od aluminijuma, ukrasni ram od hladnovaljanog lima, precizno oblikovan laserskim sečenjem.
3. Svetiljka je ofarbana epoksidnom farbom, četiri osnovne boje, na temperaturi od 180°C.
4. Svetiljka je pokretna u dve ose po max.30°.
5. Distribucija svetla se vrši preko odsijača od polikarbonata sa vakuumski nanesenim aluminijumom visoke čistoće.
6. Hladnjak "PIN heat sink" izrađen od aluminijuma AL1070.
7. Svetiljka se ugrađuje u spuštenu plafon pomoću dve torzione opruge.
8. Svetiljka je dimenzije 132x132mm h=125mm, ugradni otvor 120x110mm h_{min}=130mm.
9. Uključenje: Standard ON/OFF, Dim. cut-off triac, Dim. 1-10V, Dim. Remote 1-100%, DALI.

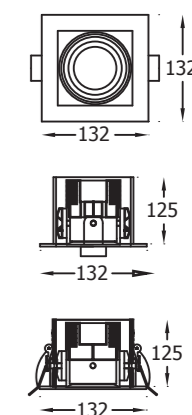

IP40

LED:	Snaga:	Temperatura boje:	Svetlosni flux:	CRI:	Ugao isijavanja:	Boja:
Sharp COB	26W	3000K	2950 lm	80	15D - 15°	bela
	26W	4000K	3100 lm	80	25D - 25°	crna
	26W	3000K	2415 lm	90	40D - 40°	siva (ram) / crna (kućište)
	26W	4000K	2525 lm	90	60D - 60°	metalik siva
	35W	3000K	3800 lm	80		
	35W	4000K	4060 lm	80		
	35W	3000K	3250 lm	90		
	35W	4000K	3350 lm	90		

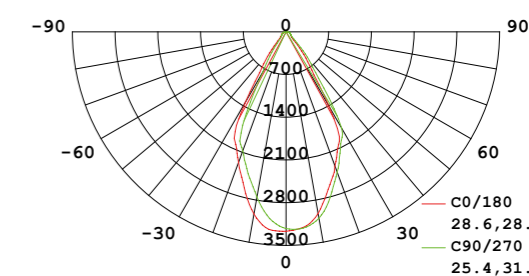
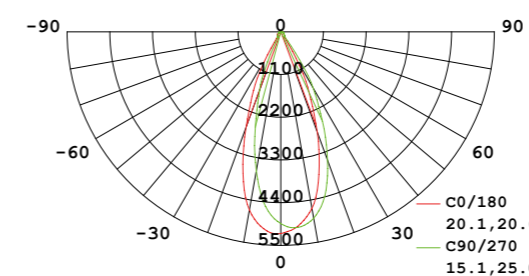
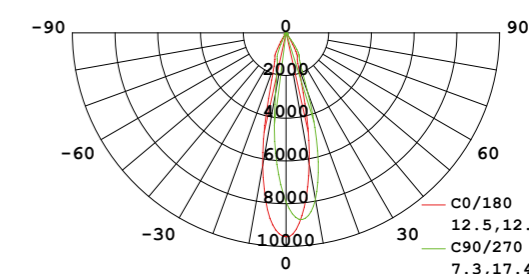
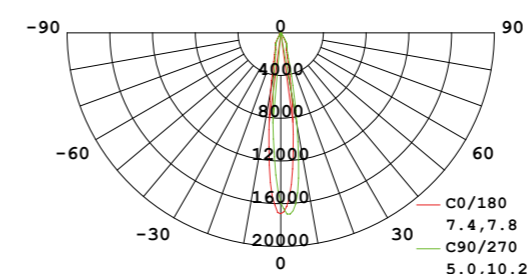



LED Q 100 2x26-35W

1. Ugradna pokretna svetiljka sa dve COB LED diode snage 26 ili 35W.
2. Kućište svetiljke izrađeno od aluminijuma, ukrasni ram od hladnovaljanog lima, precizno oblikovan laserskim sečenjem.
3. Svetiljka je ofarbana epoksidnom farbom, četiri osnovne boje, na temperaturi od 180°C.
4. Svetiljka je pokretna u dve ose po max.30°.
5. Distribucija svetla se vrši preko odsijača od polikarbonata sa vakuumski nanesenim aluminijumom visoke čistoće.
6. Hladnjak "PIN heat sink" izrađen od aluminijuma AL1070.
7. Svetiljka se ugrađuje u spuštenu plafon pomoću četiri torzione opruge.
8. Svetiljka je dimenzije 245x130mm h=125mm, ugradni otvor 215x115mm h_{min}=130mm.
9. Uključenje: Standard ON/OFF, Dim. cut-off triac, Dim. 1-10V, Dim. Remote 1-100%, DALI.

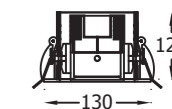
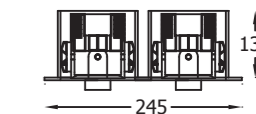
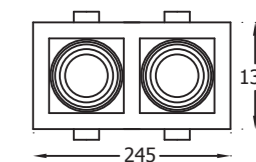

IP40

LED:	Snaga:	Temperatura boje:	Svetlosni flux:	CRI:	Ugao isijavanja:	Boja:
Sharp COB	2 x 26W	3000K	2 x 2950 lm	80	15D - 15°	bela
	2 x 26W	4000K	2 x 3100 lm	80	25D - 25°	crna
	2 x 26W	3000K	2 x 2415 lm	90	40D - 40°	siva (ram) / crna (kućište)
	2 x 26W	4000K	2 x 2525 lm	90	60D - 60°	metalik siva
	2 x 35W	3000K	2 x 3800 lm	80		
	2 x 35W	4000K	2 x 4060 lm	80		
	2 x 35W	3000K	2 x 3250 lm	90		
	2 x 35W	4000K	2 x 3350 lm	90		

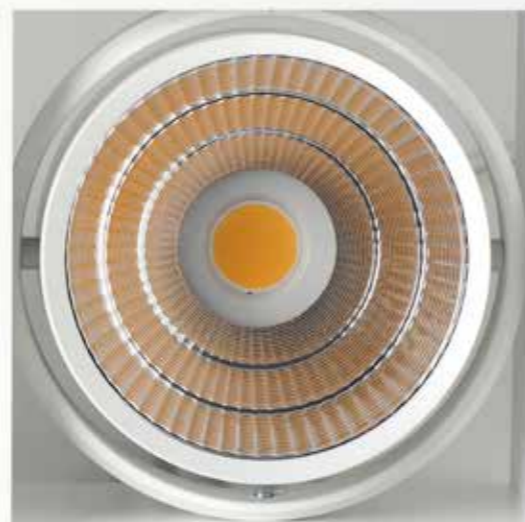
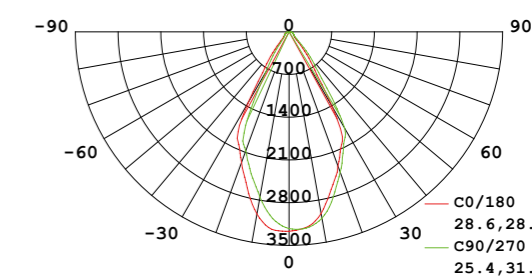
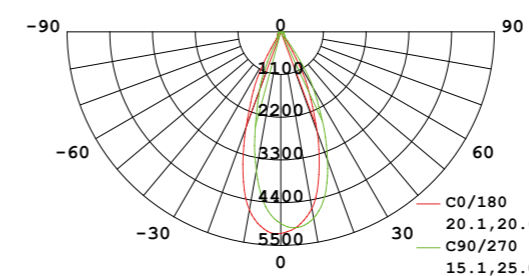
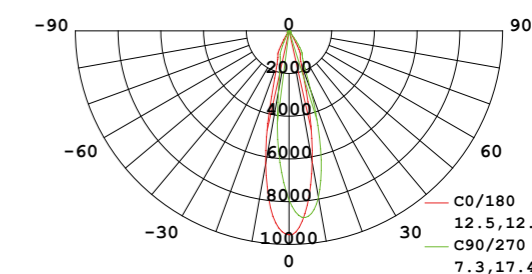
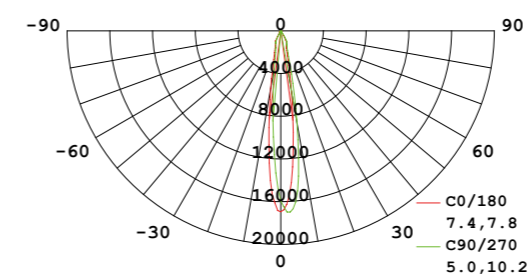



LED Q 100 3x26-35W

1. Ugradna pokretna svetiljka sa tri COB LED diode snage 26 ili 35W.
2. Kućište svetiljke izrađeno od aluminijuma, ukrasni ram od hladnovaljanog lima, precizno oblikovan laserskim sečenjem.
3. Svetiljka je ofarbana epoksidnom farbom, četiri osnovne boje, na temperaturi od 180°C.
4. Svetiljka je pokretna u dve ose po max.30°.
5. Distribucija svetla se vrši preko odsijača od polikarbonata sa vakuumski nanesenim aluminijumom visoke čistoće.
6. Hladnjak "PIN heat sink" izrađen od aluminijuma AL1070.
7. Svetiljka se ugrađuje u spuštenu plafon pomoću četiri torzione opruge.
8. Svetiljka je dimenzije 355x130mm h=125mm, ugradni otvor 330x115mm h_{min}=130mm.
9. Uključenje: Standard ON/OFF, Dim. cut-off triac, Dim. 1-10V, Dim. Remote 1-100%, DALI.

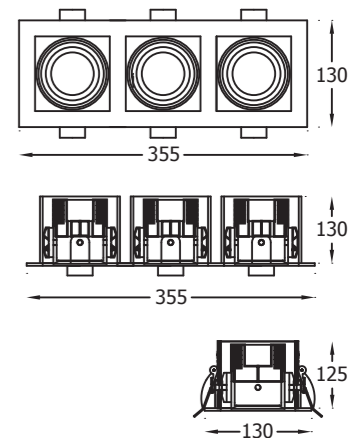

IP40

LED:	Snaga:	Temperatura boje:	Svetlosni flux:	CRI:	Ugao isijavanja:	Boja:
Sharp COB	3 x 26W	3000K	3 x 2950 lm	80	15D - 15°	bela
	3 x 26W	4000K	3 x 3100 lm	80	25D - 25°	crna
	3 x 26W	3000K	3 x 2415 lm	90	40D - 40°	siva (ram) / crna (kućište)
	3 x 26W	4000K	3 x 2525 lm	90	60D - 60°	metalik siva
	3 x 35W	3000K	3 x 3800 lm	80		
	3 x 35W	4000K	3 x 4060 lm	80		
	3 x 35W	3000K	3 x 3250 lm	90		
	3 x 35W	4000K	3 x 3350 lm	90		

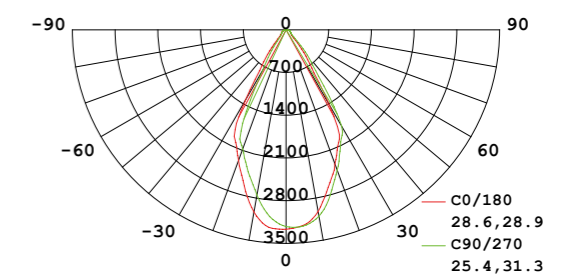
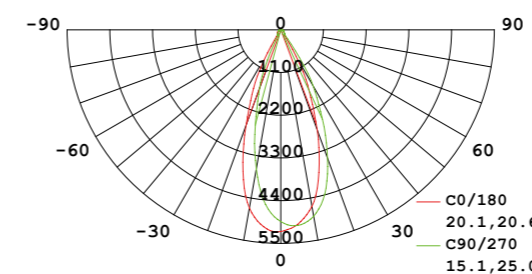
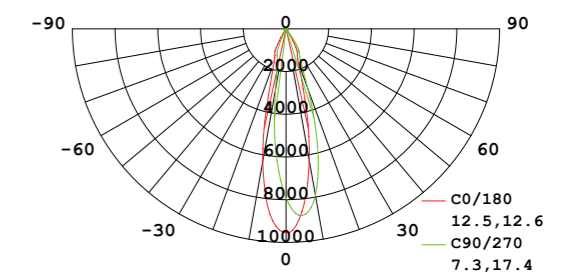
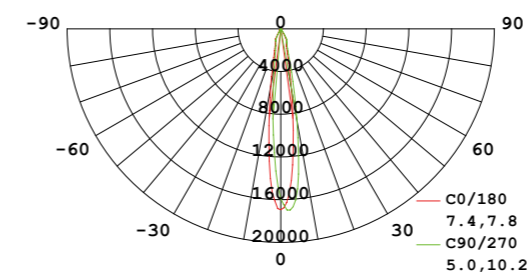



LED Q 80 1x7-10-13W

1. Ugradna pokretna svetiljka sa COB LED diodom snage 7W, 10W ili 13W.
2. Kućište svetiljke izrađeno od aluminijuma, ukrasni ram od hladnovaljanog lima, precizno oblikovan laserskim sečenjem.
3. Svetiljka je ofarbana epoksidnom farbom, četiri osnovne boje, na temperaturi od 180°C.
4. Svetiljka je pokretna u dve ose po max.30°.
5. Distribucija svetla se vrši preko odsijača od polikarbonata sa nanošenim čistim aluminijumom, vakuum tehnologijom.
6. Hladnjak "PIN heat sink" izrađen od aluminijuma AL1070.
7. Svetiljka se ugrađuje u spuštenu plafon pomoću dve torzione opruge.
8. Svetiljka je dimenzije 108x108mm h=98mm, ugradni otvor 96x85mm h_{min}=105mm.
9. Uključenje: Standard ON/OFF, Dim. cut-off triac, Dim. 1-10V, Dim. Remote 1-100%, DALI.

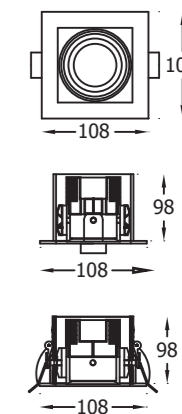

IP40

LED:	Snaga:	Temperatura boje:	Svetlosni flux:	CRI:	Ugao isijavanja:	Boja:
Sharp COB	7W	3000K	730 lm	80	15D - 15°	bela
	7W	4000K	790 lm	80	24D - 24°	crna
	7W	3000K	610 lm	90	38D - 38°	siva (ram) / crna (kućište)
	7W	4000K	645 lm	90		metalik siva
	10W	3000K	950 lm	80		
	10W	4000K	1040 lm	80		
	10W	3000K	800 lm	90		
	10W	4000K	835 lm	90		
	13W	3000K	1150 lm	80		
	13W	4000K	1230 lm	80		
	13W	3000K	930 lm	90		
	13W	4000K	965 lm	90		

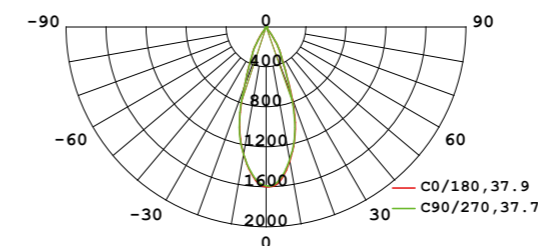
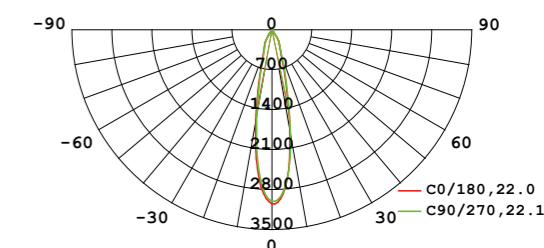
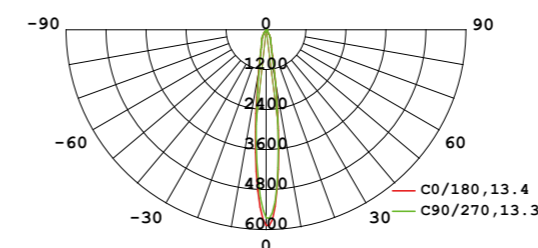

"Poslovni prostor 'Trezor Volga', Beograd



LED Q 80 2x7-10-13W

1. Ugradna pokretna svetiljka sa dve COB LED diode snage 7W, 10W ili 13W.
2. Kućište svetiljke izrađeno od aluminijuma, ukrasni ram od hladnovaljanog lima, precizno oblikovan laserskim sečenjem.
3. Svetiljka je ofarbana epoksidnom farbom, četiri osnovne boje, na temperaturi od 180°C.
4. Svetiljka je pokretna u dve ose po max.30°.
5. Distribucija svetla se vrši preko odsijača od polikarbonata sa nanošenim čistim aluminijumom, vakuum tehnologijom.
6. Hladnjak "PIN heat sink" izrađen od aluminijuma AL1070.
7. Svetiljka se ugrađuje u spuštenu plafon pomoću četiri torzione opruge.
8. Svetiljka je dimenzije 200x110mm h=98mm, ugradni otvor 175x96mm h_{min}=105mm.
9. Uključenje: Standard ON/OFF, Dim. cut-off triac, Dim. 1-10V, Dim. Remote 1-100%, DALI.

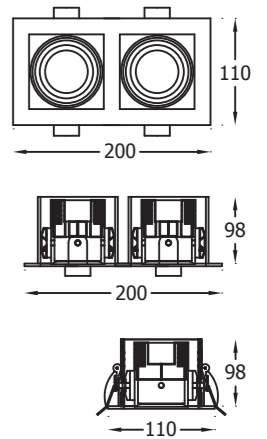

IP40

LED:	Snaga:	Temperatura boje:	Svetlosni flux:	CRI:	Ugao isijavanja:	Boja:
Sharp COB	2 x 7W	3000K	2 x 730 lm	80	15D - 15°	bela
	2 x 7W	4000K	2 x 790 lm	80	24D - 24°	crna
	2 x 7W	3000K	2 x 610 lm	90	38D - 38°	siva (ram) / crna (kućište)
	2 x 7W	4000K	2 x 645 lm	90		metalik siva
	2 x 10W	3000K	2 x 950 lm	80		
	2 x 10W	4000K	2 x 1040 lm	80		
	2 x 10W	3000K	2 x 800 lm	90		
	2 x 10W	4000K	2 x 835 lm	90		
	2 x 13W	3000K	2 x 1150 lm	80		
	2 x 13W	4000K	2 x 1230 lm	80		
	2 x 13W	3000K	2 x 930 lm	90		
	2 x 13W	4000K	2 x 965 lm	90		

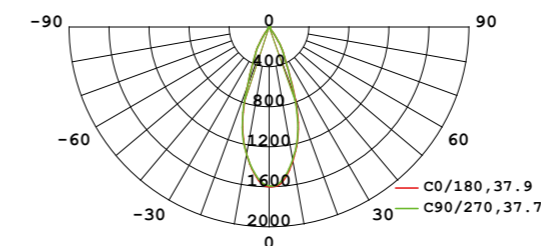
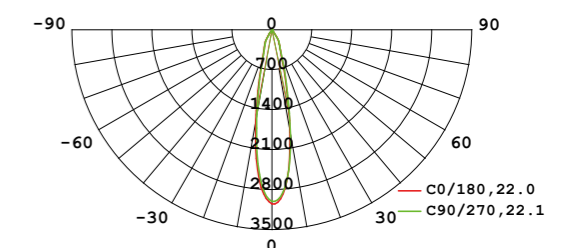
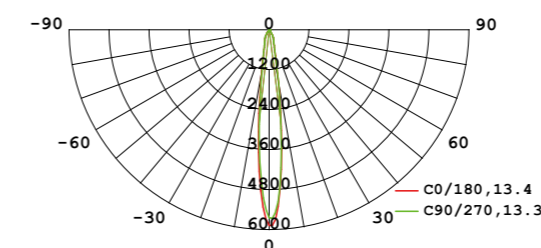



LED Q 80 3x7-10-13W

1. Ugradna pokretna svetiljka sa tri COB LED diode snage 7W, 10W ili 13W.
2. Kućište svetiljke izrađeno od aluminijuma, ukrasni ram od hladnovaljanog lima, precizno oblikovan laserskim sečenjem.
3. Svetiljka je ofarbana epoksidnom farbom, četiri osnovne boje, na temperaturi od 180°C.
4. Svetiljka je pokretna u dve ose po max.30°.
5. Distribucija svetla se vrši preko odsijača od polikarbonata sa nanošenim čistim aluminijumom, vakuum tehnologijom.
6. Hladnjak "PIN heat sink" izrađen od aluminijuma AL1070.
7. Svetiljka se ugrađuje u spuštenu plafon pomoću četiri torzione opruge.
8. Svetiljka je dimenzije 290x110mm h=98mm, ugradni otvor 265x96mm h_{min}=105mm.
9. Uključenje: Standard ON/OFF, Dim. cut-off triac, Dim. 1-10V, Dim. Remote 1-100%, DALI.

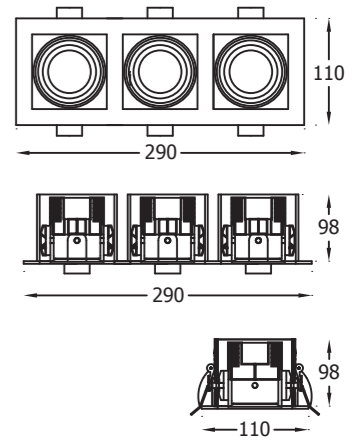

IP40

LED:	Snaga:	Temperatura boje:	Svetlosni flux:	CRI:	Ugao isijavanja:	Boja:
Sharp COB	3 x 7W	3000K	3 x 730 lm	80	15D - 15°	bela
	3 x 7W	4000K	3 x 790 lm	80	24D - 24°	crna
	3 x 7W	3000K	3 x 610 lm	90	38D - 38°	siva (ram) / crna (kućište)
	3 x 7W	4000K	3 x 645 lm	90		metalik siva
	3 x 10W	3000K	3 x 950 lm	80		
	3 x 10W	4000K	3 x 1040 lm	80		
	3 x 10W	3000K	3 x 800 lm	90		
	3 x 10W	4000K	3 x 835 lm	90		
	3 x 13W	3000K	3 x 1150 lm	80		
	3 x 13W	4000K	3 x 1230 lm	80		
	3 x 13W	3000K	3 x 930 lm	90		
	3 x 13W	4000K	3 x 965 lm	90		

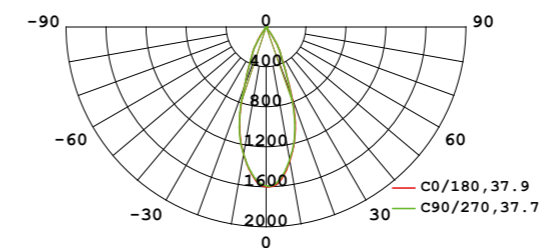
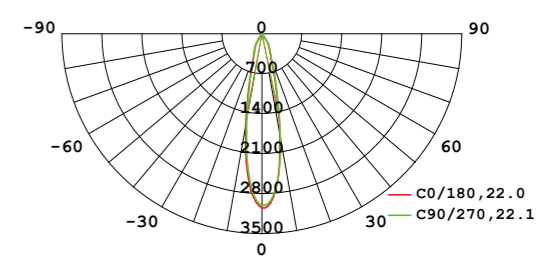
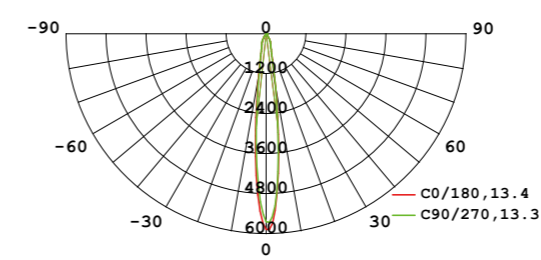

Poslovni prostor "Trezor Volga", Beograd